

Rotary actuator for ball valves

- Torque motor 5 Nm
- Nominal voltage AC/DC 24 V
- Control Open/close, 3-point
- with integrated auxiliary switch

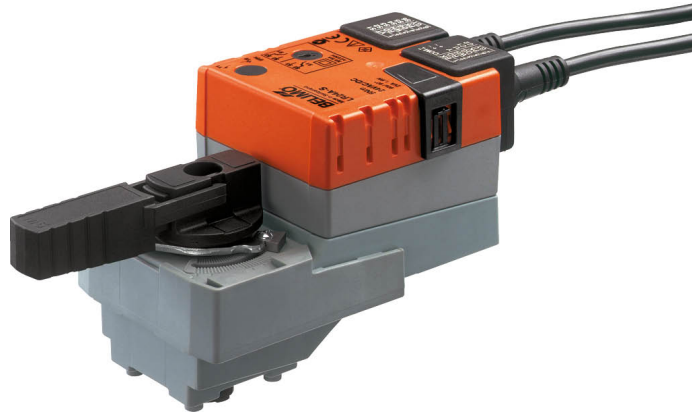

Technical data

Electrical data	Nominal voltage	AC/DC 24 V	
	Nominal voltage frequency	50/60 Hz	
	Nominal voltage range	AC 19.2...28.8 V / DC 19.2...28.8 V	
	Power consumption in operation	1.5 W	
	Power consumption in rest position	0.2 W	
	Power consumption for wire sizing	2 VA	
	Auxiliary switch	1x SPDT, 0...100%	
	Switching capacity auxiliary switch	1 mA...3 A (0.5 A inductive), DC 5 V...AC 250 V	
	Connection supply / control	Cable 1 m, 3x 0.75 mm ²	
	Connection auxiliary switch	Cable 1 m, 3x 0.75 mm ²	
	Parallel operation	Yes (note the performance data)	
	Functional data	Torque motor	5 Nm
		Manual override	with push-button, can be locked
Running time motor		90 s / 90°	
Sound power level, motor		35 dB(A)	
Position indication		Mechanical, pluggable	
Safety data		Protection class IEC/EN	III, Safety Extra-Low Voltage (SELV)
	Power source UL	Class 2 Supply	
	Protection class auxiliary switch IEC/EN	II, reinforced insulation	
	Degree of protection IEC/EN	IP54	
	Degree of protection NEMA/UL	NEMA 2	
	Enclosure	UL Enclosure Type 2	
	EMC	CE according to 2014/30/EU	
	Low voltage directive	CE according to 2014/35/EU	
	Certification IEC/EN	IEC/EN 60730-1 and IEC/EN 60730-2-14	
	UL Approval	cULus according to UL60730-1A, UL60730-2-14 and CAN/CSA E60730-1 The UL marking on the actuator depends on the production site, the device is UL-compliant in any case	
	Type of action	Type 1	
	Rated impulse voltage supply / control	0.8 kV	
	Rated impulse voltage auxiliary switch	2.5 kV	
	Pollution degree	3	
	Ambient humidity	Max. 95% RH, non-condensing	
Ambient temperature	-30...50°C [-22...122°F]		

Technical data

Safety data	Storage temperature	-40...80°C [-40...176°F]
	Servicing	maintenance-free
Weight	Weight	0.51 kg

Safety notes

- This device has been designed for use in stationary heating, ventilation and air-conditioning systems and must not be used outside the specified field of application, especially in aircraft or in any other airborne means of transport.
- Outdoor application: only possible in case that no (sea) water, snow, ice, insolation or aggressive gases interfere directly with the device and that it is ensured that the ambient conditions remain within the thresholds according to the data sheet at any time.
- Only authorised specialists may carry out installation. All applicable legal or institutional installation regulations must be complied with during installation.
- The switch for changing the direction of rotation may only be operated by authorised specialists. The direction of rotation must not in particular be reversed in a frost protection circuit.
- The device may only be opened at the manufacturer's site. It does not contain any parts that can be replaced or repaired by the user.
- Cables must not be removed from the device.
- The device contains electrical and electronic components and must not be disposed of as household refuse. All locally valid regulations and requirements must be observed.

Product features

Simple direct mounting	Straightforward direct mounting on the ball valve with only one central screw. The assembly tool is integrated in the plug-in position indication. The mounting orientation in relation to the ball valve can be selected in 90° steps.
Manual override	Manual override with push-button possible (the gear train is disengaged for as long as the button is pressed or remains locked).
Adjustable angle of rotation	Adjustable angle of rotation with mechanical end stops.
High functional reliability	The actuator is overload protected, requires no limit switches and automatically stops when the end stop is reached.
Flexible signalling	With adjustable auxiliary switch (0...100%)

Auxiliary switch

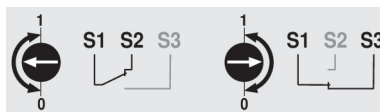
Accessories

Electrical accessories	Description	Type
	Auxiliary switch 1x SPDT add-on	S1A
	Auxiliary switch 2x SPDT add-on	S2A
	Feedback potentiometer 140 Ω add-on	P140A
	Feedback potentiometer 1 kΩ add-on	P1000A
	Feedback potentiometer 10 kΩ add-on	P10000A

Electrical installation



Supply from isolating transformer.

Parallel connection of other actuators possible. Observe the performance data.

Direction of rotation switch is covered. Factory setting: Direction of rotation Y2.

Wire colours:

- 1 = black
- 2 = red
- 3 = white
- S1 = violet
- S2 = red
- S3 = white

Wiring diagrams

AC/DC 24 V, open/close

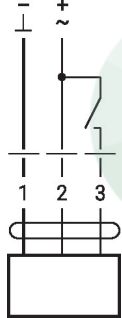

AC/DC 24 V, 3-point

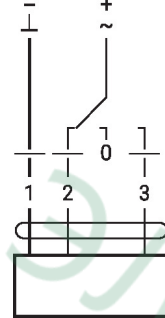

Auxiliary switch

1	2	3	
			A - AB = 100%
			stop
			A - AB = 100%

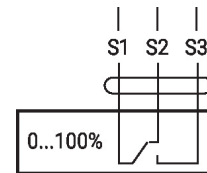

Operating controls and indicators

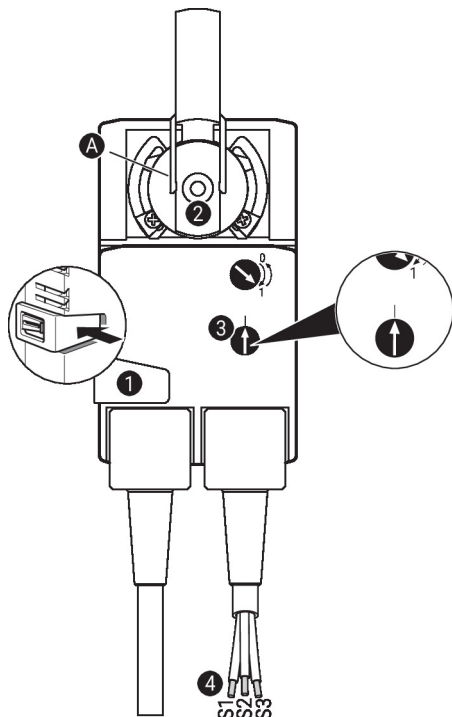

Auxiliary switch settings



Note: Perform settings on the actuator only in deenergised state.

For the auxiliary switch position settings, carry out points 1 to 4 successively.

- 1 Manual override button**
Holding button pressed down: Gear train disengages. Manual override is possible.
- 2 Shaft clamp**
Turn until edge line **A** displays the desired switching position of the actuator and release button **1**.
- 3 Auxiliary switch**
Turn rotary knob until the arrow points to the vertical line.
- 4 Cable**
Connect continuity tester to S1 + S2 or to S1 + S3.
If the auxiliary switch should switch in the opposite direction, rotate the auxiliary switch by 180°.

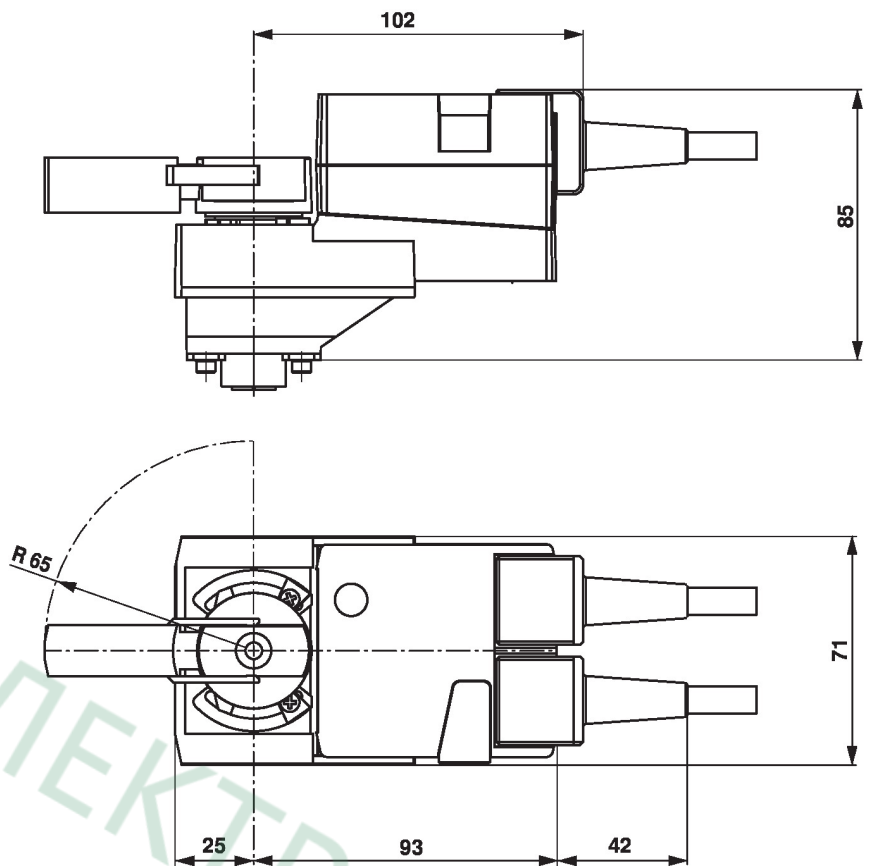
Dimensions

Further documentation

- The complete product range for water applications
- Data sheets for ball valves
- Installation instructions for actuators and/or ball valves
- General notes for project planning